



Main

Range	TeSys
Product name	TeSys GV2
Device short name	GV2P
Device application	Motor
Trip unit technology	Thermal-magnetic

Complementary

Poles description	3P
Network type	AC
Utilisation category	AC-3 conforming to IEC 60947-4-1 Category A conforming to IEC 60947-2
Network frequency	50/60 Hz conforming to IEC 60947-4-1
Fixing mode	35 mm symmetrical DIN rail: clipped Panel: screwed (with 2 x M4 screws)
Operating position	Any position
Motor power kW	15 kW at 400/415 V AC 50/60 Hz 18.5 kW at 500 V AC 50/60 Hz 22 kW at 690 V AC 50/60 Hz
Breaking capacity	100 kA Icu at 230/240 V AC 50/60 Hz conforming to IEC 60947-2 10 kA Icu at 500 V AC 50/60 Hz conforming to IEC 60947-2 4 kA Icu at 690 V AC 50/60 Hz conforming to IEC 60947-2 20 kA Icu at 440 V AC 50/60 Hz conforming to IEC 60947-2 50 kA Icu at 400/415 V AC 50/60 Hz conforming to IEC 60947-2
[Ics] rated service short-circuit breaking capacity	100 % at 690 V AC 50/60 Hz conforming to IEC 60947-2 100 % at 230/240 V AC 50/60 Hz conforming to IEC 60947-2 75 % at 500 V AC 50/60 Hz conforming to IEC 60947-2 50 % at 400/415 V AC 50/60 Hz conforming to IEC 60947-2 75 % at 440 V AC 50/60 Hz conforming to IEC 60947-2
Control type	Rotary knob
[In] rated current	32 A
Thermal protection adjustment range	24...32 A

Disclaimer: This documentation is not intended as a substitute for and is not to be used for determining suitability or reliability of these products for specific user applications

Magnetic tripping current	416 A
[Ue] rated operational voltage	690 V AC 50/60 Hz conforming to IEC 60947-2
[Ui] rated insulation voltage	690 V AC 50/60 Hz conforming to IEC 60947-2
[Ith] conventional free air thermal current	32 A conforming to IEC 60947-4-1
[Uimp] rated impulse withstand voltage	IEC 60947-2 6 kV
Power dissipation per pole	2.5 W
Mechanical durability	100000 cycles
Electrical durability	100000 cycles for AC-3 at 440 V
Maximum operating rate	25 cyc/h
Rated duty	Continuous conforming to IEC 60947-4-1
Connections - terminals	Screw clamp terminals 2 cable(s) 1...6 mm ² solid Screw clamp terminals 2 cable(s) 1.5...6 mm ² flexible without cable end Screw clamp terminals 2 cable(s) 1...4 mm ² flexible with cable end
Tightening torque	1.7 N.m on screw clamp terminals
Suitability for isolation	Yes conforming to IEC 60947-1
Phase failure sensitivity	Yes conforming to IEC 60947-4-1
Height	89 mm
Width	45 mm
Depth	97 mm

Environment

Standards	EN/IEC 60947-2 EN/IEC 60947-4-1 UL 60947-4-1 CSA C22.2 No 60947-4-1
Product certifications	IECEE CB Scheme UL CSA CCC EAC ATEX BV LROS (Lloyds register of shipping) DNV-GL RINA
Protective treatment	TH
IP degree of protection	IP20 conforming to IEC 60529
IK degree of protection	IK04
Ambient air temperature for operation	-20...60 °C
Ambient air temperature for storage	-40...80 °C
Fire resistance	960 °C conforming to IEC 60695-2-1
Operating altitude	2000 m

Offer Sustainability

Sustainable offer status	Green Premium product
REACH Regulation	REACH Declaration
EU RoHS Directive	Compliant EU RoHS Declaration
Mercury free	Yes
RoHS exemption information	Yes
China RoHS Regulation	China RoHS declaration Product out of China RoHS scope. Substance declaration for your information
Environmental Disclosure	Product Environmental Profile
WEEE	The product must be disposed on European Union markets following specific waste collection and never end up in rubbish bins

Contractual warranty

Warranty	18 months
----------	-----------

Thermal-Magnetic Tripping Curves for GV2ME and GV2P

Average Operating Times at 20 °C Related to Multiples of the Setting Current



- 1 3 poles from cold state
- 2 2 poles from cold state
- 3 3 poles from hot state

Current Limitation on Short-Circuit for GV2ME and GV2P (3-Phase 400/415 V)

Dynamic Stress

$I_{peak} = f(\text{prospective } I_{sc}) \text{ at } 1.05 U_e = 435 \text{ V}$

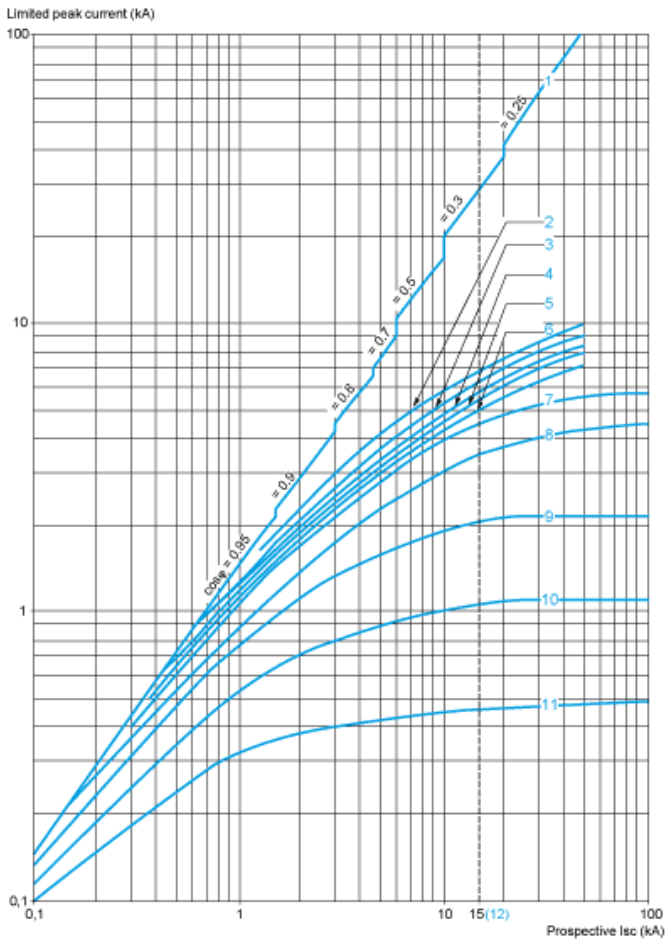

- 1 Maximum peak current
- 2 24-32 A
- 3 20-25 A
- 4 17-23 A
- 5 13-18 A
- 6 9-14 A
- 7 6-10 A
- 8 4-6.3 A
- 9 2.5-4 A
- 10 1.6-2.5 A
- 11 1-1.6 A
- 12 Limit of rated ultimate breaking capacity on short-circuit of GV2ME (14, 18, 23, and 25 A ratings).

Thermal Limit on Short-Circuit for GV2P

Thermal Limit in kA^2s in the Magnetic Operating Zone

Sum of $I^2dt = f$ (prospective I_{sc}) at $1.05 U_e = 435 V$

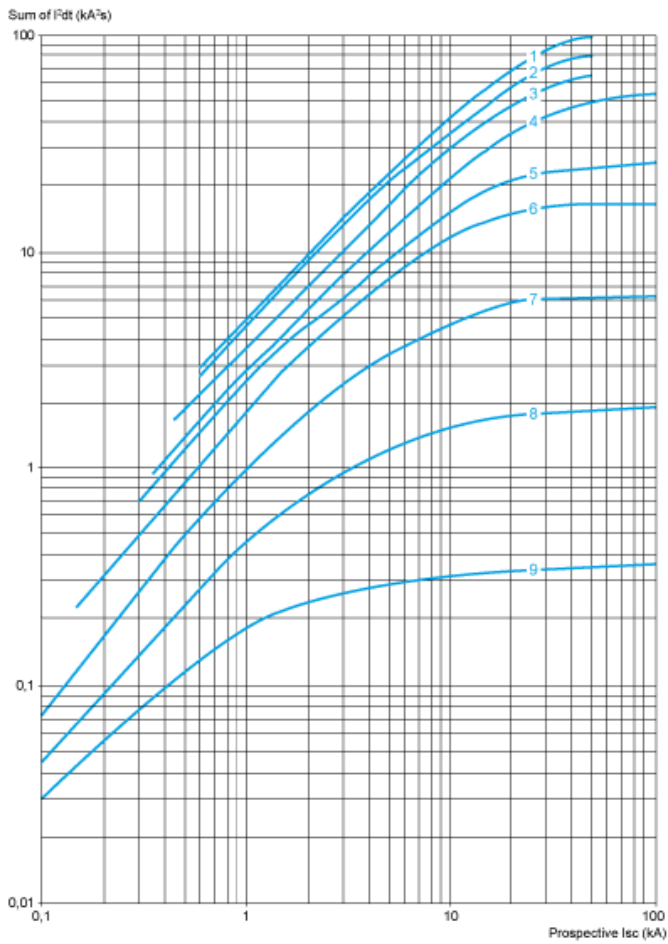

- | | |
|----|-----------|
| 1 | 24-32 A |
| 2 | 20-25 A |
| 3 | 17-23 A |
| 4 | 13-18 A |
| 5 | 9-14 A |
| 6 | 6-10 A |
| 7 | 4-6.3 A |
| 8 | 2.5-4 A |
| 9 | 1.6-2.5 A |
| 10 | 1-1.6 A |

GV2P

On rail AM1 DE200, ED200 (35 x 15)

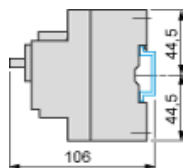

Panel mounted

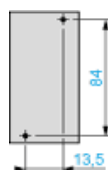

On pre-slotted plate AM1 PA

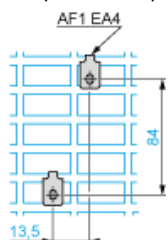

Adapter plate GK2AF01

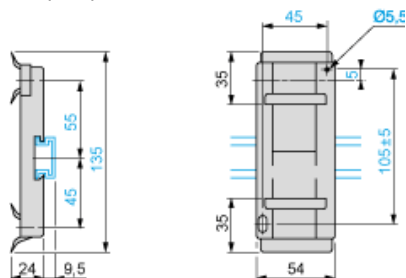

Combination GV2P + TeSys d contactor

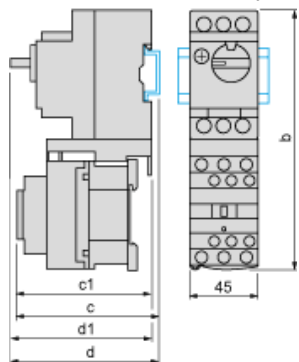

GV2P +	LC1D09...D18	LC1D25 and D32
b	176.4	186.8
c1	100.1	106.4

GV2P +	LC1D09...D18	LC1D25 and D32
c	105.6	111.9
d1	95	95
d	100.5	100.5

Mounting

Mounting of External Operator GV2APN01, GV2APN02 or GV2APN04 for Motor Circuit Breakers GV2P

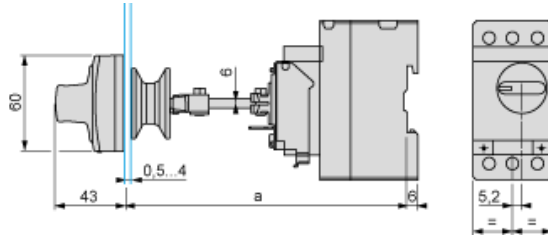

Door cut-out

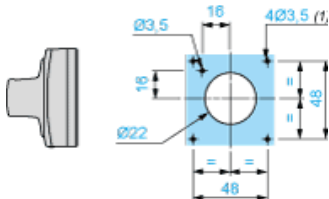

(1) For IP65 only.

Mounting of External Operator GVAPH02 for Motor Circuit Breakers GV2P

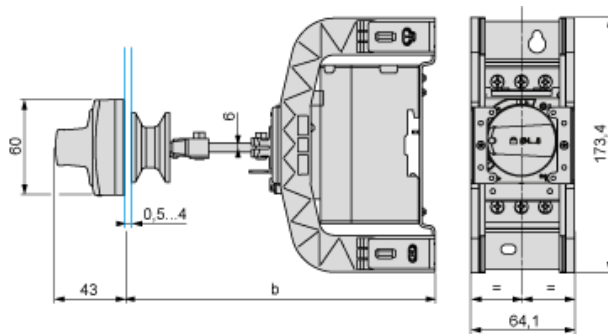

	a		b	
	Minimum	Maximum	Minimum	Maximum
GV2APN..	140	250	–	–
GV2APN.. + GVAPH02	–	–	151	250
GV2APN.. + GVAPK11	250	434	–	–
GV2APN.. + GVAPH02 + GVAPK11	–	–	250	445

Door cut-out

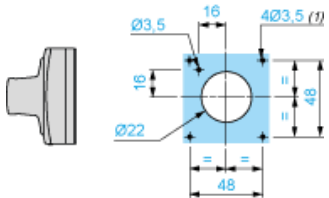

(1) For IP65 only.

GV2P..

